



NORBAR TORQUE TOOLS LTD
Widmere Road, Banbury,
Oxfordshire, OX16 3JU
UNITED KINGDOM
Tel + 44 (0)1295 270333
Email enquiry@norbar.com



NORBAR TORQUE TOOLS PTE LTD
194 Pandan Loop
#07-20 Pantech Business Hub
SINGAPORE 128383
Tel + 65 6841 1371
Email enquires@norbar.sg



NORBAR TORQUE TOOLS
45–47 Raglan Avenue, Edwardstown,
SA 5039
AUSTRALIA
Tel + 61 (0)8 8292 9777
Email norbar@norbar.com.au



NORBAR TORQUE TOOLS (SHANGHAI) LTD
91 Building-7F, No.1122 North Qinzhou Rd,
Xuhui District, Shanghai
CHINA 201103
Tel + 86 21 6145 0368
Email sales@norbar.com.cn



NORBAR TORQUE TOOLS INC
36400 Biltmore Place, Willoughby,
Ohio, 44094
USA
Tel + 1 866 667 2279
Email inquiry@norbar.us



NORBAR TORQUE TOOLS INDIA PVT. LTD
Plot No A-168, Khairne Industrial Area,
Thane Belapur Road, Mahape,
Navi Mumbai – 400 709
INDIA
Tel + 91 22 2778 8480
Email enquiry@norbar.in

www.norbar.com

3000 N·m MOTORISED TORQUE WRENCH LOADER



CONTENTS

Safety	2
Introduction	3
Parts Included	3
Accessories	3
Features & Functions	3
Installation	4
Items Required	4
Location	4
Connecting Remote Controller Box	4
Mains Plug Fitting	5
Mains Voltage Selection	5
Torque Measurement	5
Initial Free Run Test	5
Operating Instructions	6
Locating a Torque Wrench	6
Using the Motorised System	6
Emergency Stop	6
Overload	7
Hints on Torque Wrench Testing	7
Maintenance	8
Cleaning	8
Disposal	8
Specifications	8
Declaration of Conformity	9
Appendix A - Trouble shooting	10
System Not Working	10

SAFETY



- Always read and understand the manual fully before use.
- Train operating personnel to use the Motorised Torque Wrench Loader in a safe manner.
- The 3000 N·m motorised torque wrench loader is heavy (40kg). Take care when installing. Only lift by the solid metalwork.
- Ensure the operating area is capable of taking the 40kg weight of the 3000 N·m motorised torque wrench loader.
- Trapping hazard - Keep hand and loose clothing away from the torque wrench during use.
- To avoid damage to the torque wrench under test do not exceed the wrench set torque value.
- To avoid damage to the transducer do not exceed the maximum capacity.
- Never exceed the maximum torque capacity of the 3000 N·m motorised torque wrench loader (3000 N·m / 2200 lbf·ft).
- Do not operate without a torque measurement system connected and working.
- The 3000 N·m motorised torque wrench loader is designed for testing torque tools, do not use for other purposes.
- This is a powerful torque application system. Care **MUST** be taken or damage may result to the torque wrench, the torque measurement system, the torque wrench loader or injury to the operating personnel.

INTRODUCTION

The 3000 N·m Motorised Torque Wrench Loader allows torque wrenches to be calibrated and tested in an accurate and repeatable way whilst reducing operator effort.

This manual covers part number 20506 only.

Parts Included

Part Number	Description	Image
20506	3000 N·m Motorised Torque Wrench Loader	
60303	Motorised Torque Wrench Loader Lead to TST/TTT/T-Box.	
60304	Remote Paddle Controller	

Accessories

Accessories Available	Part Number
Norbar torque measurement system.	Consult Norbar

FEATURES AND FUNCTIONS

- Allows torque wrenches to be tested or calibrated to relevant standards, including BS EN ISO 6789-1:2017 and BS EN ISO 6789-2:2017, when used in an appropriate temperature-controlled environment and with appropriate ancillary equipment.
- Retains the benefits of the standard torque wrench loader.
- Ergonomically designed speed control paddle for accurate applied torque control.
- Safety transducer overload feature when used with compatible Norbar measurement system.
- Automatic motor stop without operator presence. Emergency stop override.

NOTE: A compatible Norbar measurement system must be used.

IMPORTANT: IF THE 'RED' LIGHT SHOWS REFER TO THE TROUBLE SHOOTING SECTION IN APPENDIX A.



INSTALLATION

NOTE: If the equipment is used in a manner not specified by the manufacturer, the protection provided by the equipment may be impaired.

Items Required

Norbar torque transducer to suit capacity of test with suitable torque display instrument.

Refer to the operator's manuals for both the Torque Wrench Loader and torque measurement system.

It is not possible to operate without a compatible Norbar torque measurement system.

Location

Ensure location can cope with 40kg loader weight. Locate on a level surface at a comfortable working height.

Place torque measurement system on the left hand side next to the transducer.

Place the Remote Paddle Controller in a convenient location for easy operation.



FIGURE 1 – Torque Measurement System (T-Box™ 2 Shown)



FIGURE 2 – Remote Paddle Controller



FIGURE 3 – Torque Wrench Loader

Connecting Remote Paddle Controller

1. Connect flying lead from the Remote Paddle Controller into 'REMOTE CONTROLLER' socket on the unit.
2. A compatible Norbar torque measurement system must be used to facilitate transducer overload protection. The lead is supplied for TST/TTT/ T-Box connection (60303). Connect the 3 way socket into 'TTT/T-BOX ANCILLARIES' on unit. Connect 15 way plug to ancillaries socket of a Norbar TST, TTT or T-Box.

Mains Plug Fitting

If a mains plug is not fitted, follow the plug's own instructions. The following may be useful:

BROWN-LIVE

BLUE-NEUTRAL

GREEN / YELLOW-EARTH



WARNING! IT IS IMPORTANT THAT LIVE, NEUTRAL AND EARTH ARE ALL CONNECTED BETWEEN THE MOTORISED TORQUE WRENCH LOADER AND THE MAINS SUPPLY. IF NO EARTH IS AVAILABLE (2 WIRE MAINS SUPPLY) IT IS RECOMMENDED THAT A SEPARATE EARTH IS CONNECTED BETWEEN THE CONTROL BOX AND A SUITABLE EARTH.

If the plug has an internal fuse, a 1 amp value is recommended.

Mains Voltage Selection

Ensure mains voltage is correctly set, the control box has a setting draw next to the mains input on back panel.

The orientation of this drawer can be changed by removing the drawer with a small flat screwdriver.

Align arrow of required voltage with marker.

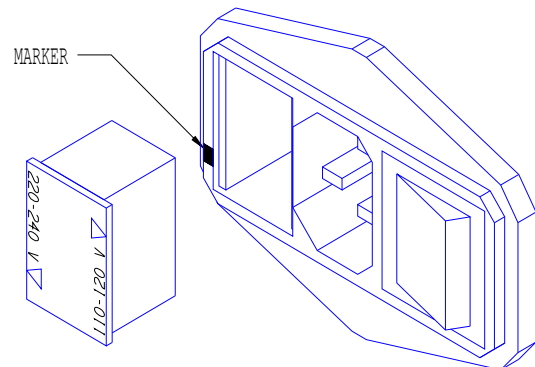

FIGURE 4 – Mains Voltage

Torque Measurement

Use parts supplied with Torque Wrench Loader, torque measurement system and transducer.

Refer to relevant operator's manual for torque measurement system and transducer to be used.

Select the lowest capacity torque transducer to cover the wrench to be tested.

Mount the male square of the transducer into the female square of the gear box, use adaptors to suit. A 1" square drive transducer will fit directly, others will require 1/4", 3/8", 1/2" or 1 1/2" adapter. The appropriate locating collar should be placed over the top of the transducer and locked by rotating through 90 degrees.

Connect a transducer lead from the transducer to the instrument.

Connect the ancillaries lead from the instrument to the Torque Wrench Loader.

Ensure the instrument functions correctly. (If in doubt see operators manual).

Initial Free Run Test

With electrical supplies to the system and mains switches 'ON'. The GREEN LED will light. Press the 'RESET' button on the back panel to initialise the system. The 'RED' LED will extinguish, if not refer to Appendix A - Trouble Shooting. (Page 10)

**NOTE: PULL paddle to rotate the final drive anti-clockwise - DIRECTION A.
PUSH paddle to rotate the final drive clockwise - DIRECTION B.**

OPERATING INSTRUCTIONS

Locating a Torque Wrench

Please refer to Torque Wrench Loader operator's manual.
Select the correct adapter to place the torque wrench drive into transducer.

Set the reaction post position on the reaction arm so it is in the middle of the torque wrench handle or the marked load point on the handle.

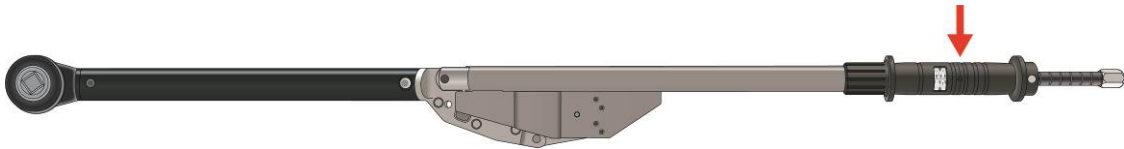

FIGURE 5

Set the reaction post height to ensure the wrench handle is parallel to the reaction arm.

Using the Motorised System

The large gear box ratio makes movement in the output drive difficult to detect.
Use the 'A' and 'B' arrows on the control box and gearbox output as an indication.

For clock-wise calibration 'A' indicates direction to apply force & 'B' indicates direction to release force.

- a) **Pull** paddle to rotate torque wrench loader in direction **A** (anticlockwise).

The more the paddle is moved, the faster the loader will rotate.

Release paddle to stop rotation.
Paddle will automatically return to the 'STOP' position.

- b) **Push** paddle to rotate torque wrench loader in direction **B** (clockwise).

TIP: In the case of a ratchet wrench, with push through square drives, it is important to ensure the square is operating on the correct side of the ratchet.

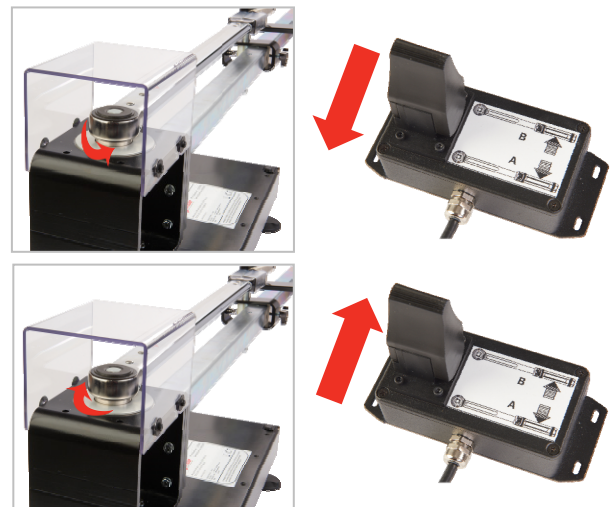

FIGURE 6 – Clockwise & Anti-clockwise Operation

Emergency Stop

Press the RED 'EMERGENCY STOP' button to STOP the system. Remove the cause of the problem.
Press the 'RESET' button on the back panel to initialise the system.

Overload

System	Overload action
T-Box	The overload is activated by the 'HI' of the measurement system limit detector; refer to limit settings in measurement system manual.
TTT	When the torque value reaches the HI (high) limit the system will stop and the RED LED illuminate. To release the overload:
TST	Move paddle in the opposite direction to the overload and ensure torque is decreasing.
Pro-Log	Press the 'RESET' button on the back panel to initialise the system after the torque has been removed.

TIP: Place torque instrument into **TRACK** mode to ensure torque is decreasing.

Hints on Torque Wrench Testing

1. On small torque values the break point can be difficult to detect - care must be taken. It is recommended to use a long auto reset hold time, see measurement system manual. STOP loading when the measurement system detects the wrench break (the measuring system displays the <STOP> logo) even though the torque wrench click may not be heard. Use the first torque reading, as the second is the relaxed wrench reading.
2. If down loading data to a computer or printer, false readings may occur when the wrench is being unloaded. To stop the false readings use the LOG/NO LOG feature (Pro-Log) or PRINT/NO PRINT feature (TST or TTT) or SAVE / NO SAVE feature (T-Box).

MAINTENANCE

The Motorised Torque Wrench Loader is engineered for a long maintenance free life. Under normal operation maintenance is not required.
For maintenance and recalibration of the torque instrument and transducer refer to their manuals.

Cleaning

Do not use abrasives or solvent based cleaners. Norbar recommend a propriety brand of foam based fabric / vinyl cleaner. Use a soft cloth to avoid scratches.

Disposal



Do not dispose of this product with the general waste. To follow European Directive 2002/96/EC on WEEE (waste electrical and electronic equipment) this product must be sent to a recycling facility.

SPECIFICATIONS

Maximum Torque Output:	3000 N·m / 2200 lbf·ft
Torque Wrench Length:	With small reaction plate option = 125mm to 210mm Standard reaction arm = 220mm to 1100mm With extension arm = up to 2200mm
Voltage Requirements:	Selectable 110/120 Volts AC +/- 10 % or 220/240 Volts AC +/- 10% at 50/60 Hz.
Mains Power Fuse:	T1A anti-surge for 220VAC. T2A anti-surge for 110VAC.
Power Consumption:	100 W – maximum.
Mains Power Cable:	2.5 meters long.
Ancillaries Input:	3 Way 'Binder 680 Series' plug.
Direction Of Torque Application:	Clockwise and Anticlockwise.
Overload (T-Box, TST, TTT or Pro-Log):	5V DC as given by HI limit set.
Operating Temperature Range:	0 °C to +40 °C.
Storage Temperature Range:	-20 °C to +70 °C.
Sound Pressure Level:	L_{pA} does not exceed 70 dB(A).
Maximum Operating Humidity:	80% Relative Humidity @30°C.
Weight:	Remote Paddle Controller: 0.25 kg Torque Wrench Loader 40 kg
Base Dimensions:	120 mm high x 830 mm wide x 310 mm deep.
Dimensions (without extension bar)	554mm high x 1232mm wide x 382 deep
Dimensions (with extension bar)	554mm high x 2442mm wide x 382 deep
Environment:	Indoor use within a light industrial environment. To environmental conditions Pollution Degree 2 & Installation Category (Overvoltage Category) II.

NOTE: If equipment is used in a manner not specified by the manufacturer, the protection provided by the equipment could be impaired.

EU Declaration of Conformity (No 0014V2)

This declaration of conformity is issued under the sole responsibility of the manufacturer.

The object of the declaration:

Motorised Torque Wrench Loader kit (Model: 60194).
 Motorised Torque Wrench Loader ISO 1500 (Model: 60193).
 Motorised Torque Wrench Loader ISO 3000 (Model: 20506).
 Serial Number – All.



The object of the declaration described above is in conformity with the relevant union harmonisation legislation:

Directive 2006/42/EC on Machinery Directive.
 Directive 2014/30/EU on Electromagnetic Compatibility.
 Directive 2011/65/EU of the European Parliament and of the Council of 8 June 2011 on the restriction of the use of certain hazardous substances in electrical and electronic equipment (RoHS).

The object of the declaration described above has been designed to comply with the following standards:

EN ISO 12100:2010 Safety of machinery. General principles for design. Risk assessment and risk reduction
 EN 61326-1:2013 Electrical equipment for measurement, control and laboratory use. EMC requirements.

The basis on which conformity is being declared:

The technical documentation required to demonstrate that the products meet the requirements of the above Directives has been compiled by the signatory below and is available for inspection by the relevant enforcement authorities.

The CE mark was first applied in: 1998.

The authorised representative within the European Union (EU) is:

Francesco Frezza Snap-on Equipment S.r.l. Via Prov. Carpi, 33 42015 Correggio RE Italy

Signed for and on behalf of Norbar Torque Tools Ltd.

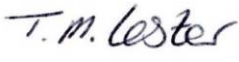
Signed:  **Full Name:** Trevor Mark Lester B.Eng.
Date: 1 April 2021 **Authority:** Compliance Engineer
Place: Norbar Torque Tools Ltd., Wildmere Road, Banbury, Oxfordshire. OX16 3JU

APPENDIX A - TROUBLE SHOOTING

System Not Working

IS GREEN (POWER) LED ON? → NO



YES

IS RED (RESET) LED ON? → YES



NO

DOES SYSTEM OPERATE? → NO

Reason	Action
No mains power.	Check mains supply.
Incorrect mains drawer selection.	Ensure drawer orientation is correct to suit mains supply.
Fuse in mains plug blown.	Replace fuse. A value of 2A is recommended.
Fuse in mains input on back panel blown.	Use 2A for 110 VAC and 1A for 220 VAC

Reason	Action
System initially turned ON.	Press 'RESET' to initialise system
Torque measurement system not working / connected.	Check measurement system is functioning.
Emergency Stop pressed	Remove hazard. Press 'RESET' to initialise system.
Overload protection activated	Refer to OVERLOAD section on page 7. Ensure torque is decreasing.

Reason	Action
Other	Return to Norbar for repair.

Always replace fuses with same value and type.

